

\_\_\_\_\_

\_\_\_\_\_

\_\_\_\_\_

\_\_\_\_\_





**TRX 特锐祥**  
专 注 电 容 器 廿 年





	<b>SMD- 1</b> <b>SMD 1 . .</b>		
	/N		/D
	/E		/P



/N

/E

1. /P N

T G 1 102 K

2. /E









/N

SMD- 1  
SMD 1 . .



 <b>TRX</b> 专注电容器廿年	<b>SMD- 1</b>		
	<b>SMD 1 . .</b>		
	/N		/D
/E		/P	

/

/

**7. /P**









/N

/D

/E

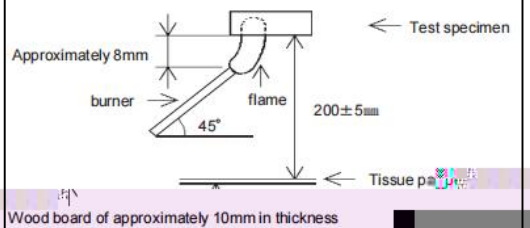
/P



 <b>TRX</b> 专注电容器廿年	<b>SMD- 1</b> <b>SMD 1 . .</b>		
	/N		/D
	/E		/P

8. /C

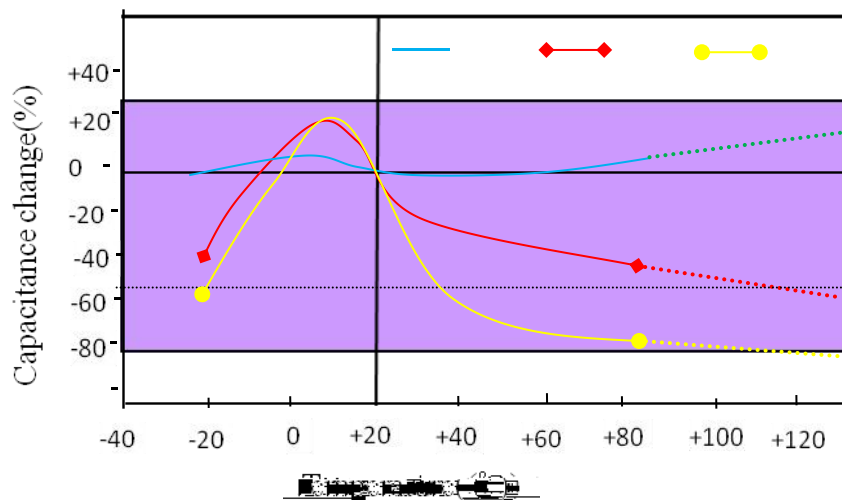



11. /P

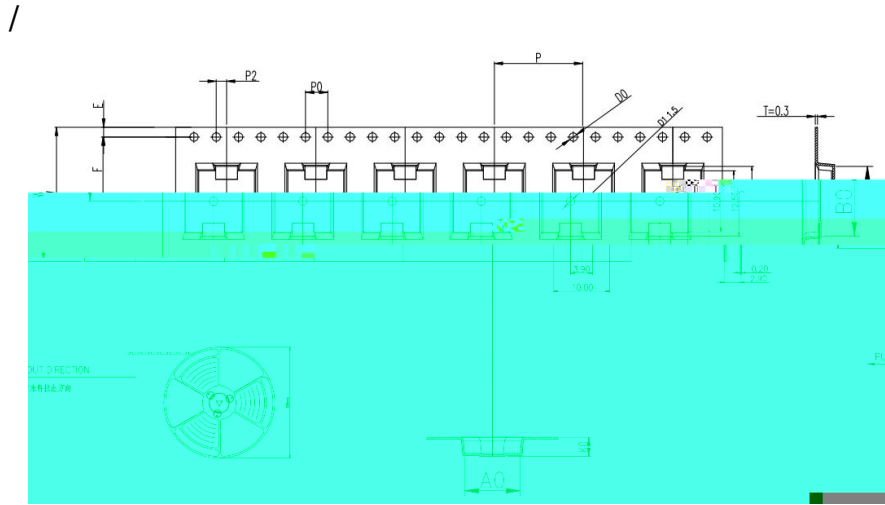

ITEM	W	A0	B0	K1	K0	P	F	E	D0	D1	P0	P2	T											
DIM	24.0	$^{+0.30}_{-0.30}$	$^{+0.10}_{-0.10}$	$^{+0.10}_{-0.10}$	$^{+0.10}_{-0.10}$	3.45	$^{+0.10}_{-0.10}$	16.0	$^{+0.10}_{-0.10}$	11.50	$^{+0.10}_{-0.10}$	1.75	$^{+0.10}_{-0.10}$	$\varnothing 1.5$	$^{+0.10}_{-0.00}$	$\varnothing 1.5$	$^{+0.10}_{-0.00}$	4.0	$^{+0.10}_{-0.10}$	2.0	$^{+0.10}_{-0.10}$	0.30	$^{+0.05}_{-0.05}$	
ALTERNATE																								

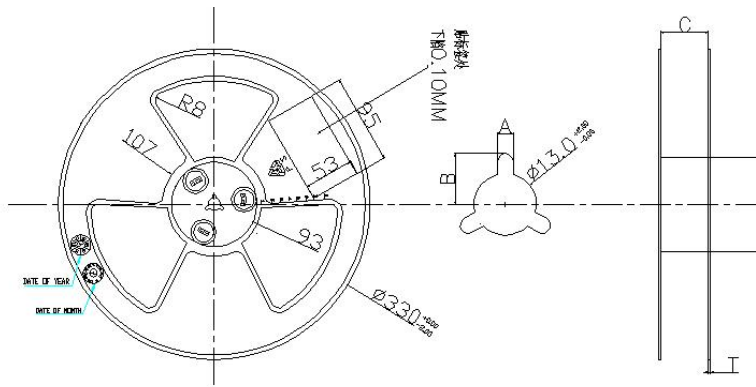

SPEC	A±0.3	B±0.5	C $^{+0.5}_{-0.0}$	D±0.5	T±0.2
24	2.3	10.75	24.4	Ø97	2.2

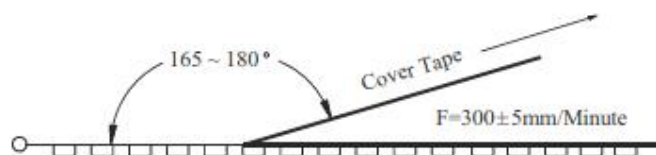

Item	Data	Remark
Cover tape adhesion	10 ~ 100g	Carrier tape and cover tape open angle 165 ~ 180° F=300± 5mm/minute



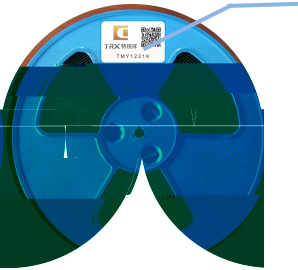

 <b>TRX</b> 专注电容器廿年	<b>SMD- 1</b> <b>SMD 1 . .</b>		
	/N		/D
	/E		/P

/ -





TRX 特锐祥  
TGY1102K

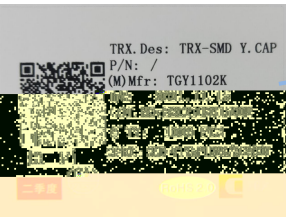

TRX Des: TRX-SMD Y. CAP  
P/N: /  
(M) Mfr: TGY1102K

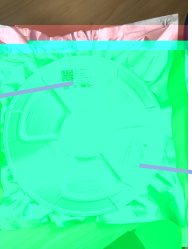

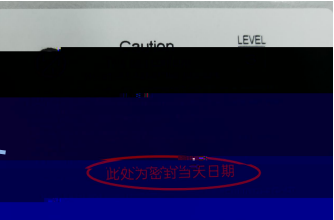



Caution LEVEL  
此处为密封当天日期

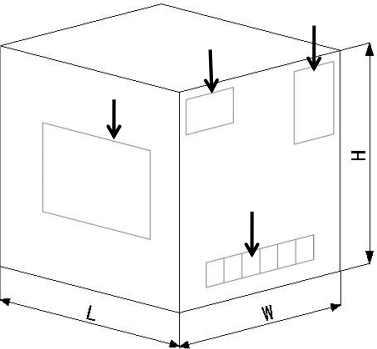

/O -





TRX 特锐祥  
专注电容器







TRX Des: TRX-SMD Y. CAP  
P/N: /  
(M) Mfr: TGY1102K

/
/
/

/P :









/
/

R

