



深圳市弗瑞鑫电子有限公司

规格承认书

—

prepare	
check	
approve	



TRX电容一级代理商

深圳市弗瑞鑫电子有限公司

Add:深圳市宝安区西乡大道302号金源商务大厦B座3楼

Tel:0755-29563634

Fax:0755-27447020

2

2 . .

/

/

/

/

	2 2 . .		
	/		/
	/		/

	2 $2 \dots$		
	/		/
	/		/

1. /

$\overline{\text{①}}$ $\overline{\text{②}}$ $\overline{\text{③}}$ $\overline{\text{④}}$ $\overline{\text{⑤}}$ $\overline{\text{⑥}}$

①

4. /

5. /





①		
②		
③		
④		
⑤		

2
2 ..

/

/

/ /

	2 2 ..		
	/		/
	/		/

/

°
°C

°

°

°

/

7. /

	2 2 . .		
	/		/
	/		/



HS6PJ 1 0 TD[(H) J 120 0 TD[(Q)]TJ]TJ 67.1885 0 TD[(K)]TJ 117.594 0 TD[(H)N i -8363.97 -125]TJ 117.594 0

 TRX 专注电容器廿年	2		
	2 . .		
	/		/
	/		/



TRX
 专注电容器廿年

2
 2 ..

/

/

/

/

		△	
		△	
		△	
		△	
		△	
		△	
		△	
		△	
		△	
		△	

8. /

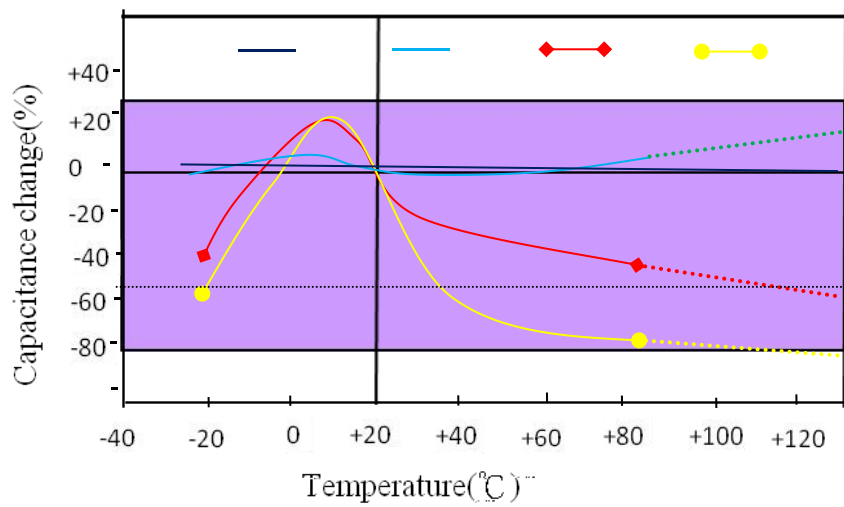

11. /
/

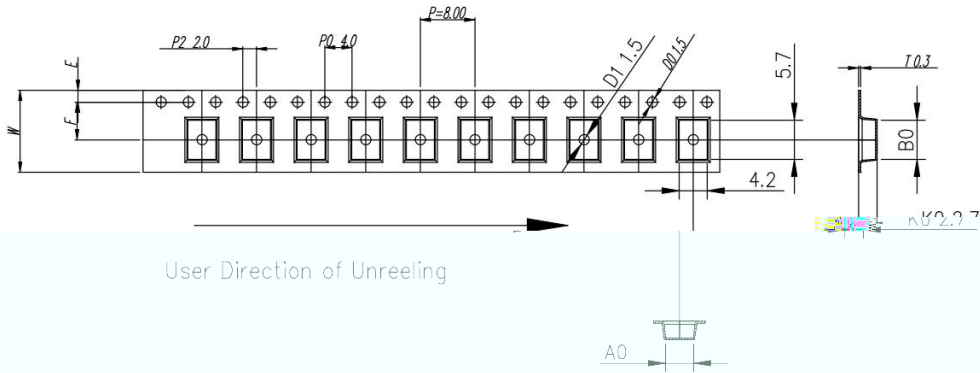

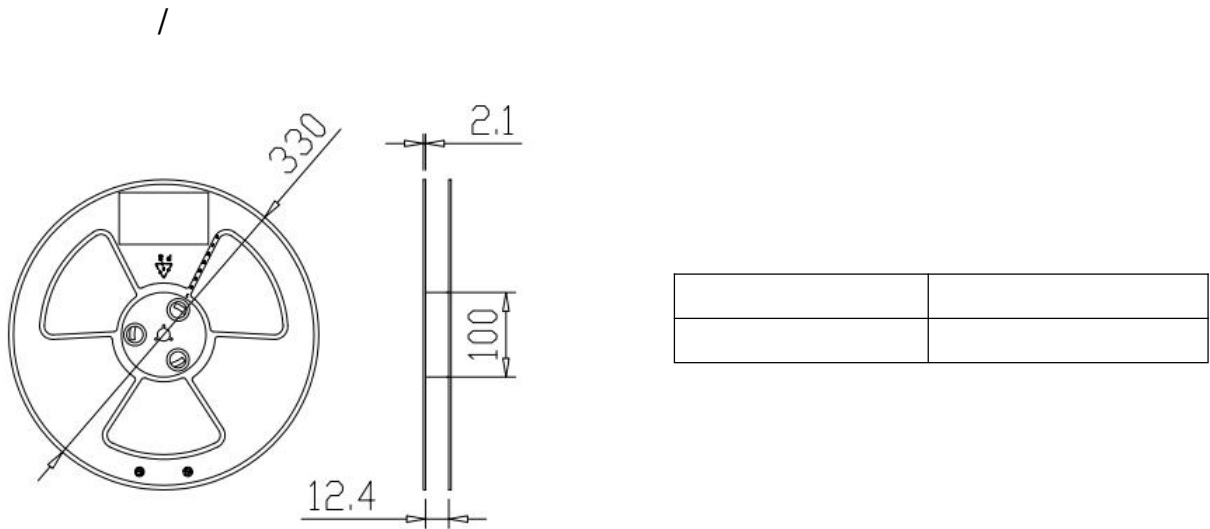

ITEM	W	A0	B0	K1	K0	P	F	E	D0	D1	P0	P2	T
DIM	12.0 ±0.30	4.2 ±0.10	5.70 ±0.10	--	2.70 ±0.10	8.00 ±0.10	5.50 ±0.10	1.75 ±0.10	∅1.5 ±0.05	∅1.5 ±0.10	4.0 ±0.10	2.0 ±0.10	0.30 ±0.05
ALTERNATE													





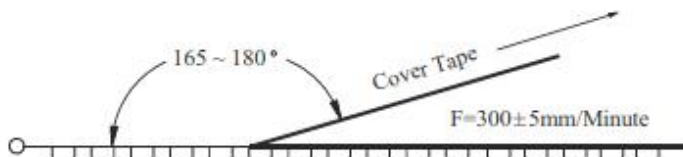

/



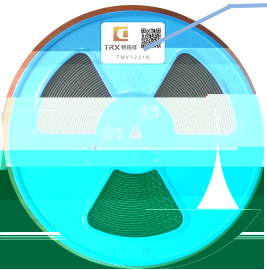

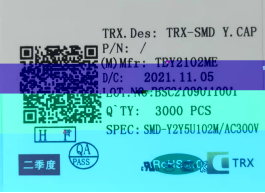
Item	Data	Remark
Cover tape adhesion	10 ~ 100g	Carrier tape and cover tape open angle 165 ~ 180° F=300±5mm/minute

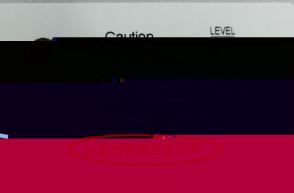

 TRX 专注电容器廿年	2 2 . .			
	/		/	
	/		/	

/ -	 <p>标签</p>	 <p>料号</p>		
				

/ -				
	图示 /	图示 /	图示 /	

/ :				
	/	/		

--	--	--	--	--

	2 2 . .		
	/		/
	/		/

12.

①

②