

TRX 特锐祥
专注电容器材料



SMD- 1			
SMD 1 . .			
/N		/D	
/E		/P	

/ I

/ II
 TR SMD- 1.CAP
 C R T.CD (: F

T.C						

	SMD- 1 SMD 1 . .		
	/N		/D
	/E		/P



SMD- 1
SMD 1 . .

/N

/D

/E

/

/P N

T G 1 102 K

/P

	<p>B Y1 100K-100V SAE ccc</p>
--	---



/N

SMD- 1
SMD 1 . .

 TRX 专注电容器廿年	SMD- 1		
	SMD 1 . .		
	/N		/D
/E		/P	

/

/

7. /P

 TRX 专注电容器廿年	SMD- 1		
	SMD 1 . .		
	/N		/D
	/E		/P

				<table border="1" style="width: 100%; height: 20px;"> <tr> <td></td><td></td><td></td><td></td><td></td><td></td> </tr> <tr> <td></td><td></td><td></td><td></td><td></td><td></td> </tr> </table>													
				±													



SMD- 1
SMD 1 . .

/N

/D

/E

/P

±

 TRX 专注电容器廿年	SMD- 1		
	SMD 1 . .		
	/N		/D
	/E		/P

/N

/D

/E

/P

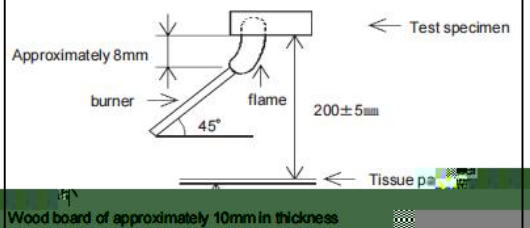

 TRX 专注电容器廿年	SMD- 1 SMD 1 . .		
	/N		/D
	/E		/P

			± ±
			± ±
			± ±
			± ±
			± ±
			± ±
			± ±
			± ±
			± ±

8. /C

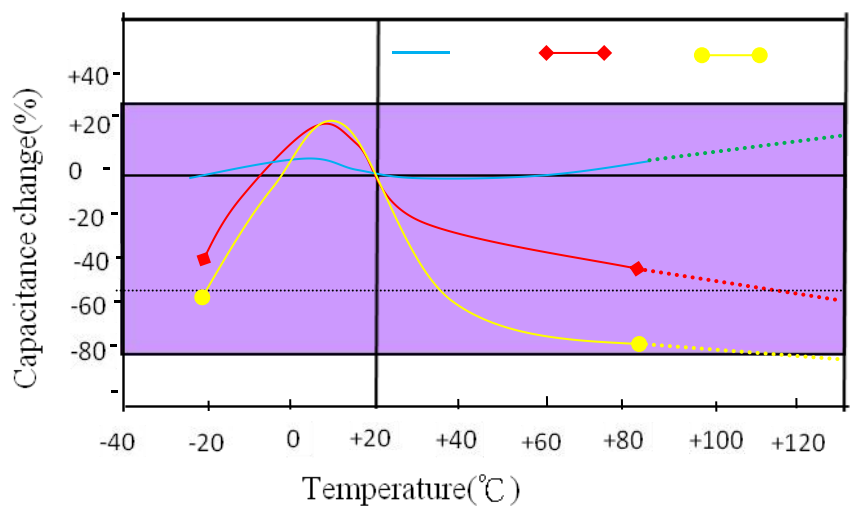

 TRX 专注电容器廿年	SMD- 1		
	SMD 1 . .		
	/N		/D
/E		/P	

9. /C

**R HS H.F.
REACH**

10. /S

/

/

11. /P

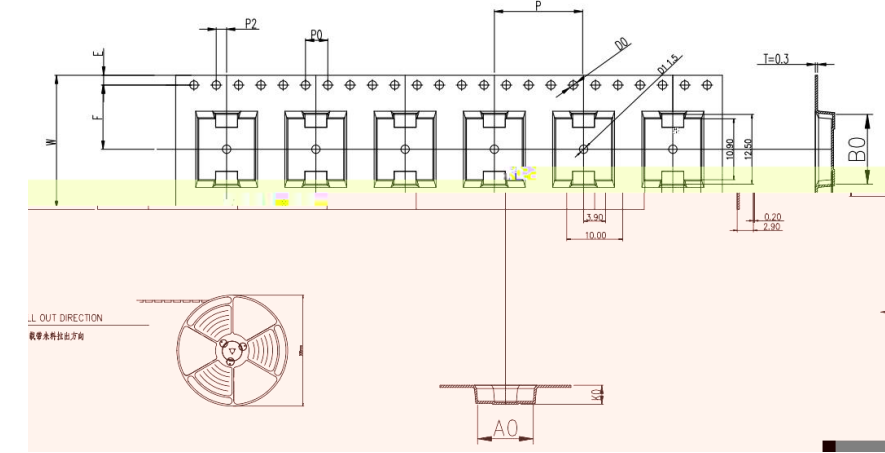

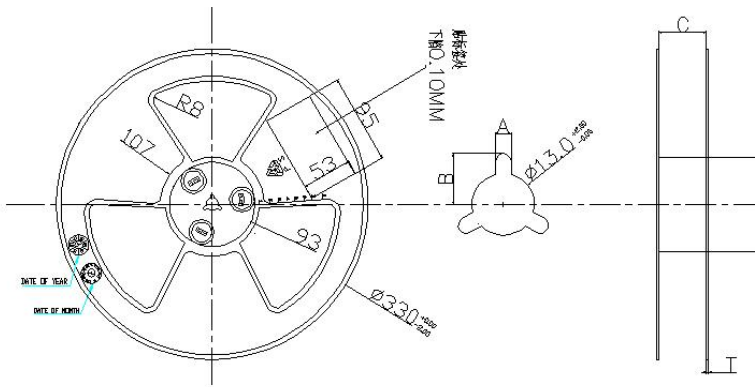

ITEM	W	A0	B0	K1	K0	P	F	E	D0	D1	P0	P2	T
DIM	24.0	$^{+0.30}_{-0.30}$	$^{+0.10}_{-0.10}$	$^{+0.10}_{-0.10}$	$^{+0.10}_{-0.10}$	$^{+0.10}_{-0.10}$	$^{+0.10}_{-0.10}$	$^{+0.10}_{-0.10}$	$^{+0.10}_{-0.00}$	$^{+0.10}_{-0.00}$	$^{+0.10}_{-0.10}$	$^{+0.10}_{-0.10}$	$^{+0.05}_{-0.05}$
ALTERNATE													





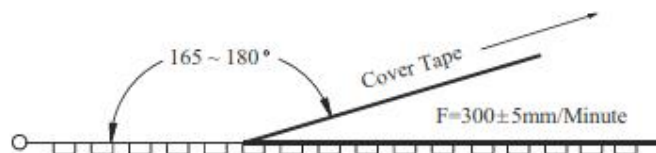

SPEC	A±0.3	B±0.5	C $^{+0.5}_{-0.0}$	D±0.5	T±0.2
24	2.3	10.75	24.4	Ø97	2.2

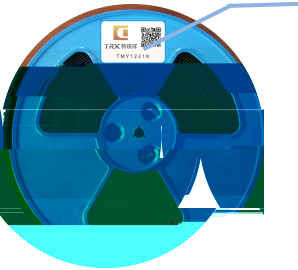
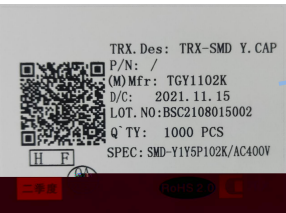

Item	Data	Remark
Cover tape adhesion	10 ~ 100g	Carrier tape and cover tape open angle 165 ~ 180° F=300± 5mm/minute

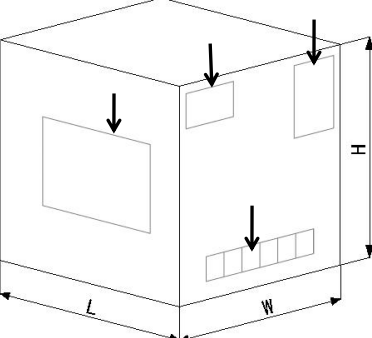

 TRX 专注电容器廿年	SMD- 1		
	SMD 1 . .		
	/N		/D
		/P	

/ -	 			
				

/O -				
		/	/	/

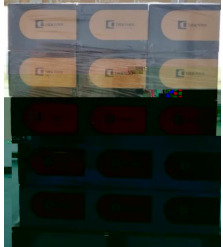
/P :				
	/	/		

" "				
R				

	SMD- 1 SMD 1 . .		
	/N		/D
	/E		/P

12. /A