

\_\_\_\_\_

\_\_\_\_\_

\_\_\_\_\_

\_\_\_\_\_







**TRX 特锐祥**  
专注电容器材料





	<b>SMD- 1</b> <b>SMD 1 . .</b>		
	/N		/D
	/E		/P

 <b>TRX</b> 专注电容器廿年	<b>SMD- 1</b> <b>SMD 1 . .</b>		
	/N		/D
	/E		/P

1. /P N



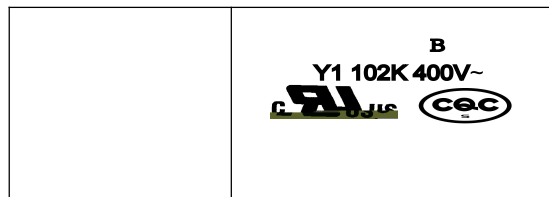

**T G \_1 102 K**

		×

2. /P



 <b>TRX</b> 专注电容器廿年	<b>SMD- 1</b> <b>SMD 1 . .</b>		
	/N		/D
	/E		/P

/E	
	
	±          ±
   	

3. /D

↓									
↓									
			↓						
			↓						



 <b>TRX</b> 专注电容器廿年	<b>SMD- 1</b>		
	<b>SMD 1 . .</b>		
	/N		/D
/E		/P	



6. /S  
/

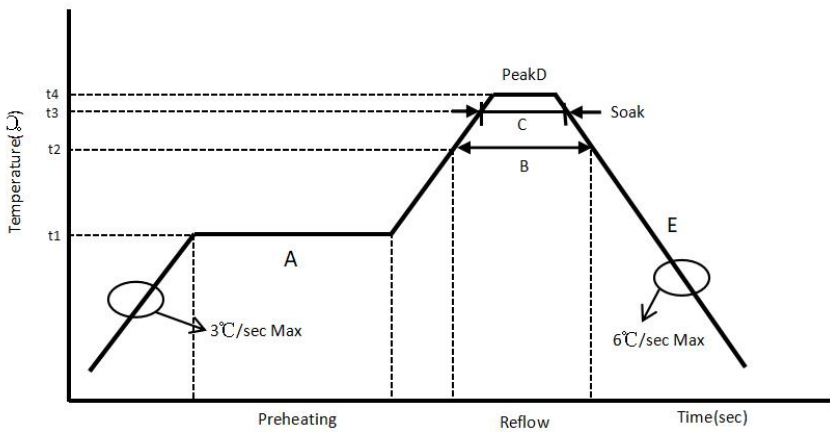



 <b>TRX</b> 专注电容器廿年	<b>SMD- 1</b>		
	<b>SMD 1 . .</b>		
	/N		/D
/E		/P	

/

/

7.            /P











 <b>TRX</b> 专注电容器廿年	<b>SMD- 1</b>		
	<b>SMD 1 . .</b>		
	/N		/D
/E		/P	

			± ±
			± ±
			±
			± ±
			± ±
			±

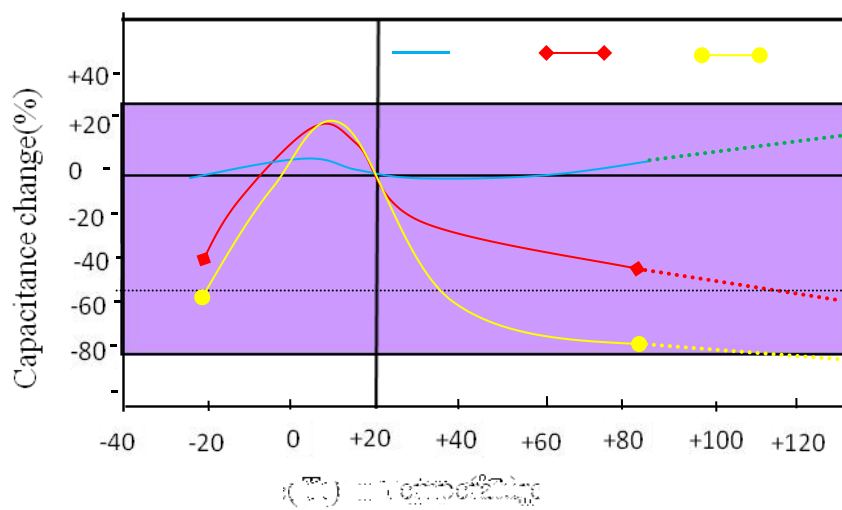
8. /C





11. /P

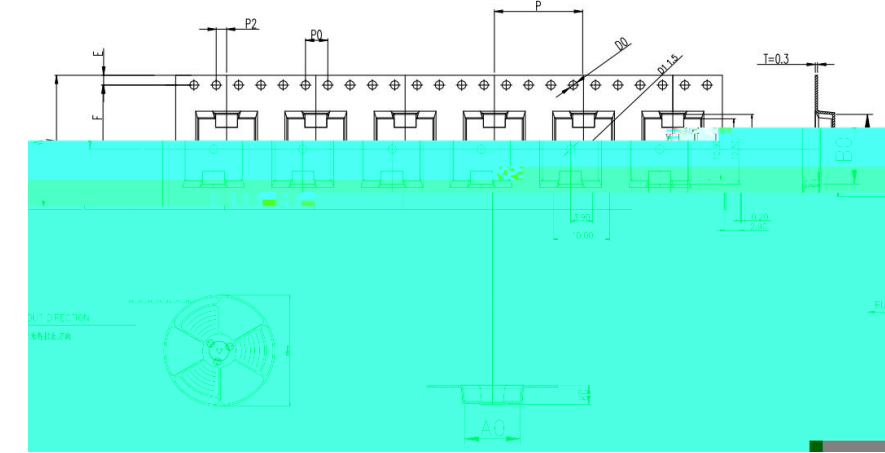

ITEM	W	A0	B0	K1	K0	P	F	E	D0	D1	P0	P2	T
DIM	24.0	$+0.30$ $-0.30$	$+0.10$ $-0.10$	$+0.10$ $-0.10$	3.45	$+0.10$ $-0.10$	$+0.10$ $-0.10$	$+0.10$ $-0.10$	$\pm 0.00$	$+0.10$ $-0.10$	$+0.10$ $-0.10$	$+0.10$ $-0.10$	$+0.05$ $-0.05$

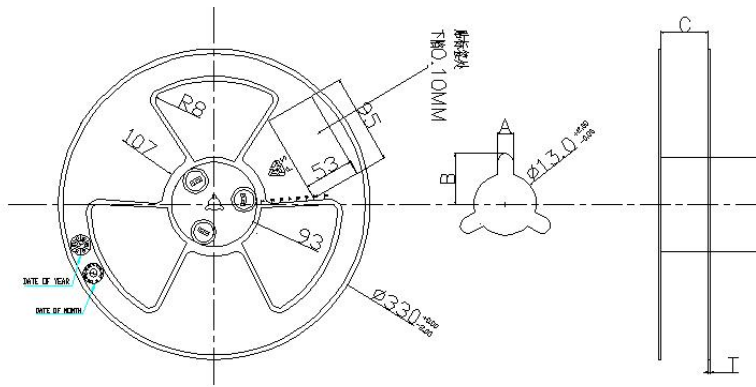

SPEC	A±0.3	B±0.5	C $^{+0.5}$ $_{-0.0}$	D±0.5	T±0.2
24	2.3	10.75	24.4	Ø97	2.2

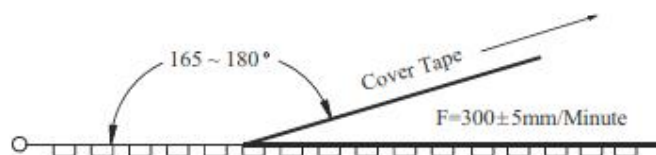

Item	Data	Remark
Cover tape adhesion	10 ~ 100g	Carrier tape and cover tape open angle 165 ~ 180° F=300± 5mm/minute





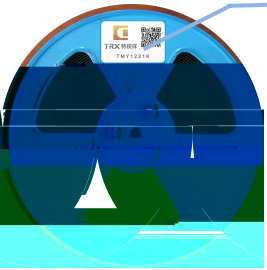

 <b>TRX</b> 专注电容器廿年	<b>SMD- 1</b> <b>SMD 1 . .</b>		
	/N		/D
	/E		/P

/ -





TRX 特锐祥  
TGY1102K



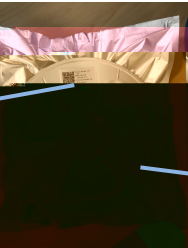

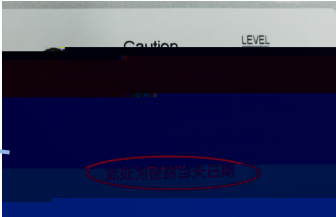



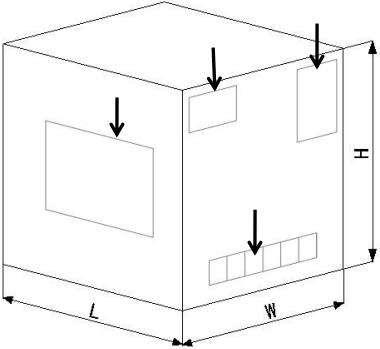

/O -













/
/
/

/P :









/
/

" "

R

